

Article number: 20132B45B45652SW
Description: E+G 2-way pipe clamp
GN 132-B45-B45-65-2-SW

Measures

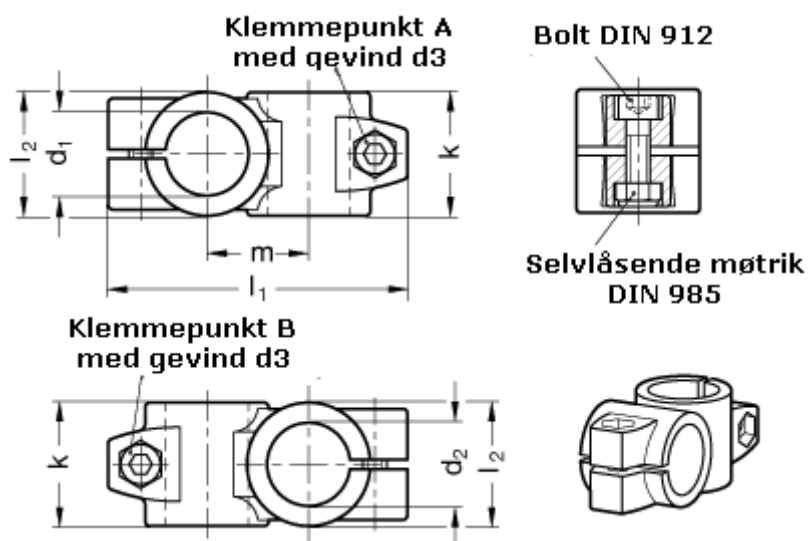

Adjustable clamp lever = GN 911-M10-55 have to be ordred separately

d1	= 45
d2	= 45
d3	= M10
k	= 65
l1	= 143.0
l2	= 65
m	= 53